

4006-8B BRIDGE TOWER & C18655 TOP MOUNTED DRAINER WITH 408 FAUCETS OR 525SS FAUCETS MOUNTING TEMPLATE

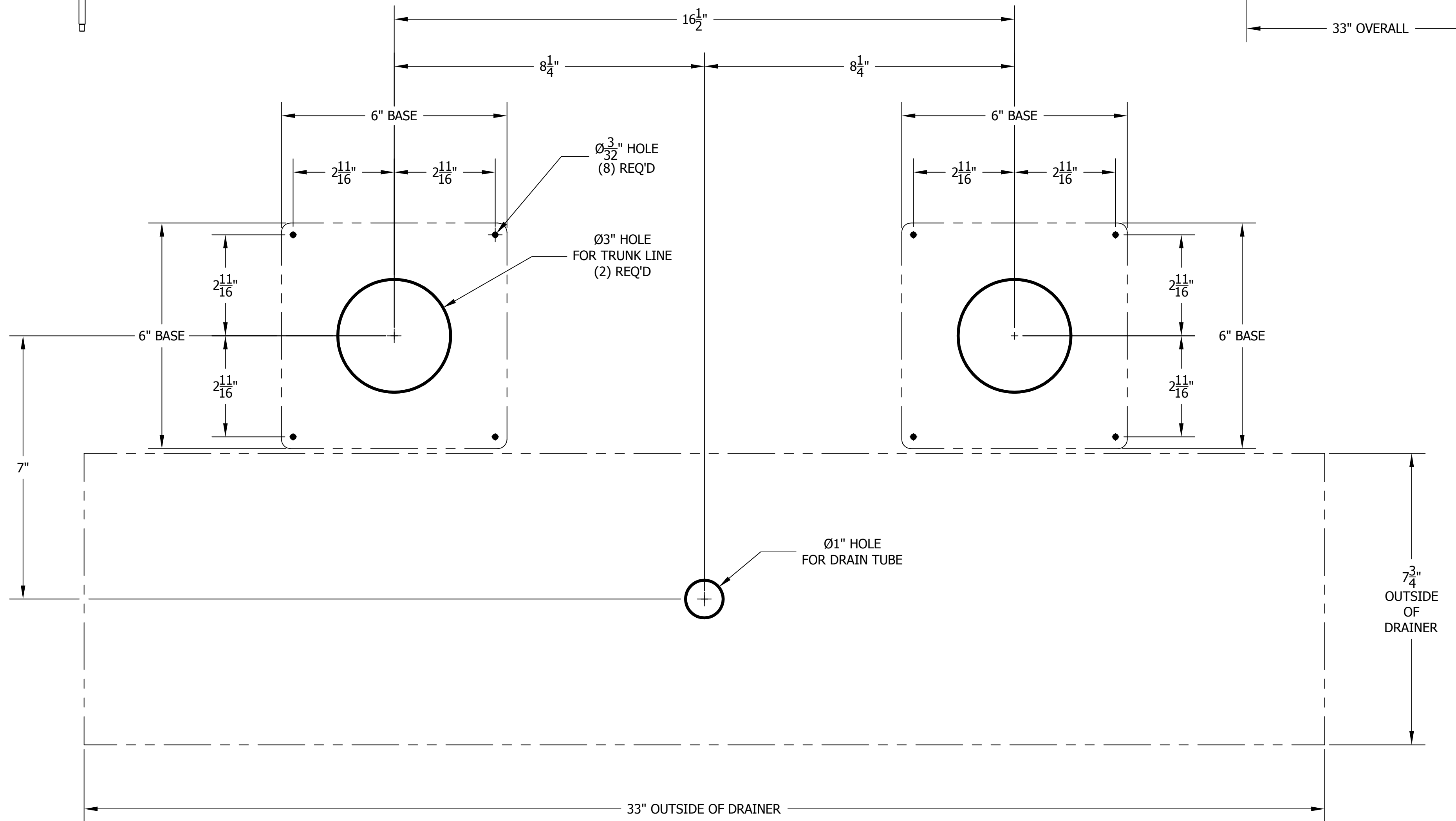

****DRAWING NOT TO FULL SCALE****

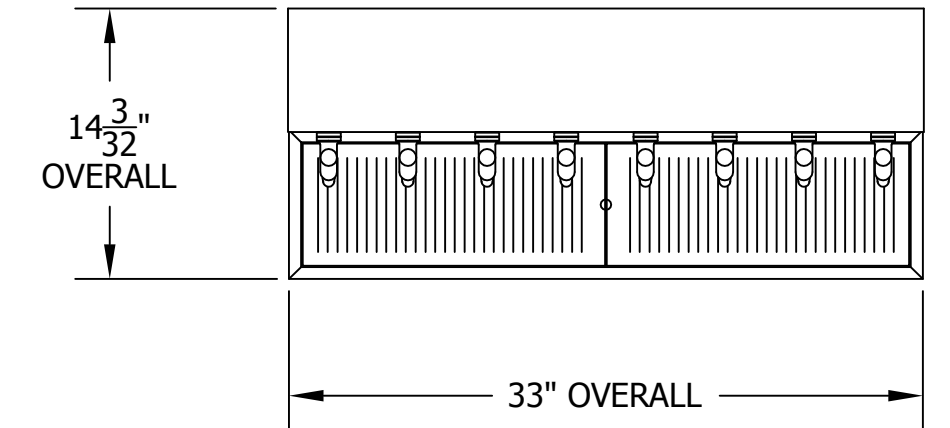
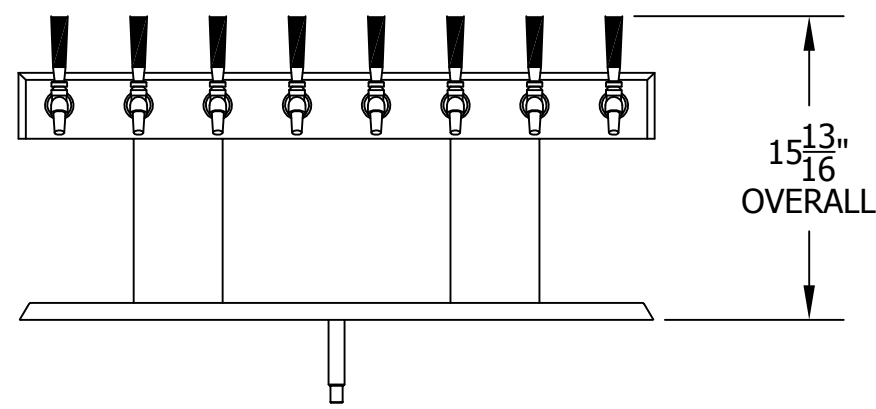

PERLICK CORPORATION
MILWAUKEE, WI 53223
PROPERTY OF THE PERLICK CORP.
NOT TO BE COPIED OR USED DETRIMENTAL TO OUR INTERESTS.

SCALE 1:2
DR. JMP DATE 6/3/2011

LAST MODIFIED
6/13/2011

94063